



PRODUCT DATA

DIMENSIONS, TECHNICAL INFORMATION AND PERFORMANCE SPECIFICATION

trendvario 6100+



Table of contents

Explanation of symbols.....	2	Arrangement of grids – KombiSystem.....	7
Function diagram with standard designation.....	2	Access incline.....	8
Dimensions and tolerances.....	2	Clearance for installations.....	8
Overview of building configuration.....	3	CE conformity.....	9
Vehicle data.....	3	Electrical installation.....	10
Overview of system types and ceiling heights.....	4	Technical information.....	10
Width dimension and door height.....	5	Performance specification.....	11
Configuration with sliding door.....	5	Services to be provided by the customer.....	13
Configuration with sliding door.....	6	Subject to technical changes.....	13
Loading schedule.....	7		

Explanation of symbols



Platforms accessible horizontally.



max. load per parking space in kg.
Upweighting over 2000 kg possible with surcharge (see "Vehicle data", page 3).



Parking space load can be subsequently upweighted (see "Vehicle data", page 3).



Traversable and can be combined with other TrendVario systems as a KombiSystem.



The systems provided are consistent with DIN EN 14010, the VDMA 15423 specification and the EC Machinery Directive 2006/42/EC.



This system has also undergone a voluntary compliance test conducted by TÜV SÜD.

Function diagram with standard designation



Example for vehicle on basement level (LF) of grid 3:
Selection via the control panel; all doors must be closed.
Representation of parking spaces in a row.

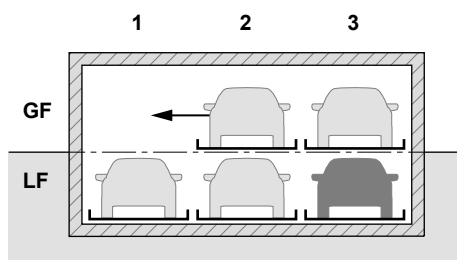

To remove the vehicle from the space in **grid 3/LF**, the GF platforms are moved to the left.

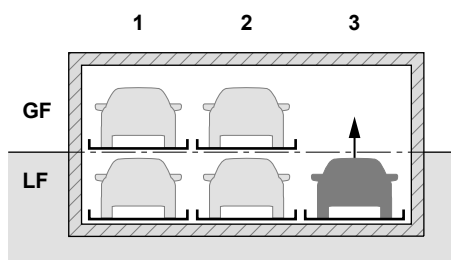

The empty space is now located above the vehicle being removed. The parking space in **grid 3/LF** is raised.

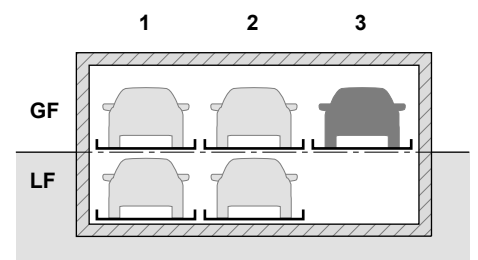

The vehicle in the space in **grid 3/LF** can now be removed.

Dimensions and tolerances



All dimensions and minimum final dimensions.
Tolerance for dimensions +3/-0. Dimensions in cm.
In order to adhere to the minimum final dimensions, the tolerances in accordance with the German Construction Tendering and Contract Regulations [VOB], Part C (DIN 18330 and 18331) and DIN 18202 must also be taken into account.

Overview of building configuration

Building configuration without door detail 6

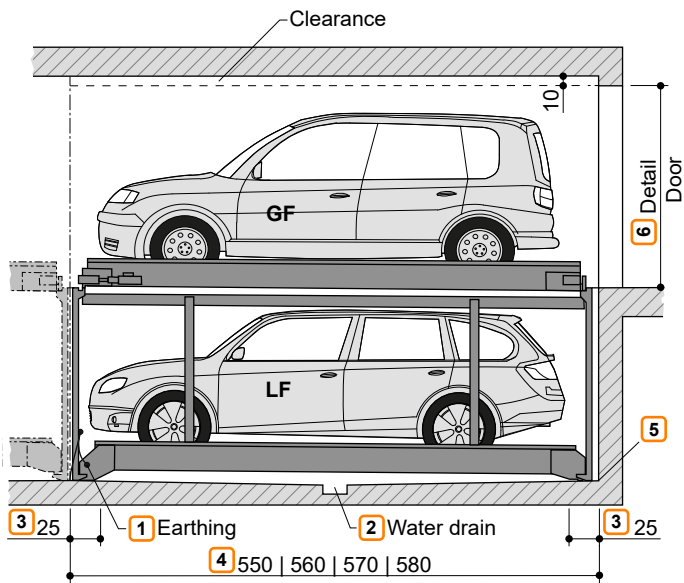

- 1 Equipotential bonding from foundation earth connection to system (to be provided by the customer).
- 2 Slope with water collection channel (see "Drainage", page 13).
- 3 These areas must be horizontal and at the same level throughout the pit.
- 4
 - 550 cm for vehicles up to 5.0 m long
 - 560 cm for vehicles up to 5.1 m long
 - 570 cm for vehicles up to 5.2 m long
 - 580 cm for vehicles up to 5.3 m long
 Shorter versions are possible on request - observe local regulations on parking space lengths. For comfortable use of your parking space and increasingly longer vehicles, we recommend a minimum pit length of 570 cm.
- 5 No fillets/haunches are permitted at the transition from the pit floor to the walls. If fillets/haunches are required, the systems must be narrower or the pits wider.
- 6 Door detail and other door variants (see "Configuration with sliding door", page 5 and see "Configuration with sliding door", page 6)



If fire-extinguishing systems are required, the customer must ensure that sufficient clearance is provided.

KombiSystem examples

Combination 6100 with 6100+

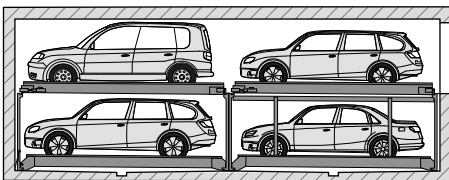

Combination 6200+ with 6100+

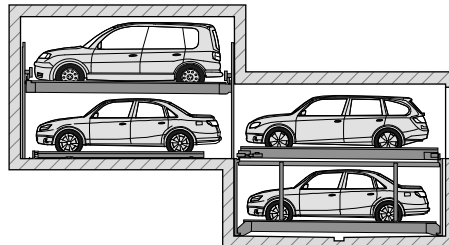

Combination 6300 with 6100+

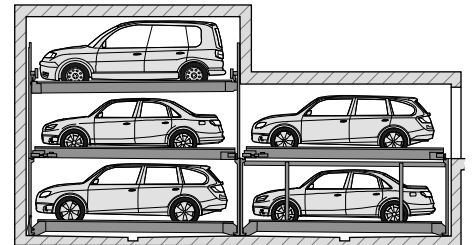

Vehicle data

Parking options

Series vehicles:
saloon, estate, SUV, van in accordance with clearance gauge and maximum parking space load.

	GF LF 3		
Weight 4	2000 kg	2600 kg	3000 kg
Wheel load	500 kg	650 kg	750 kg

- 1 Vehicle height (see "Overview of system types and ceiling heights", page 4)
- 2 Vehicle length (see "Overview of building configuration", page 3)
- 3 GF = ground floor | LF = lower floor
- 4 Individual space loads can also be subsequently upweighted to 3000 kg.

Clearance gauge

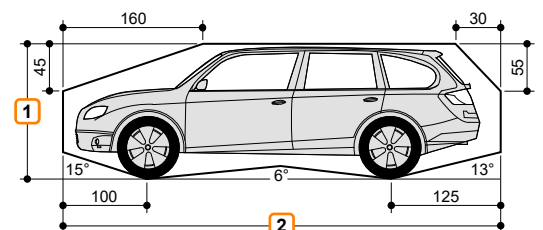

Vehicle width 190 cm with platform width 230 cm. Correspondingly wider vehicles can be parked with wider platforms.

Overview of system types and ceiling heights



The permissible vehicle height, GF must be 10 cm greater than the vehicle height, lower floor.

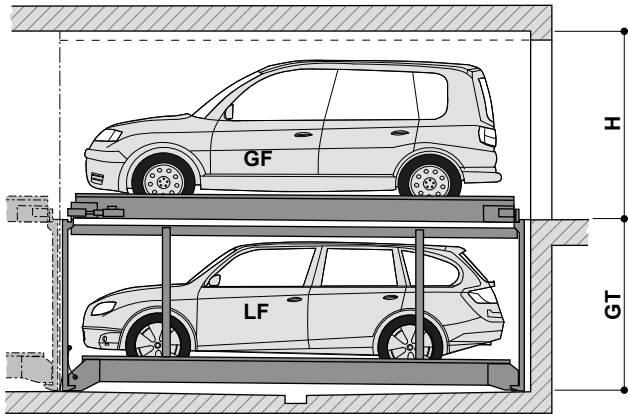

H: Ceiling height
GT: Pit depth

Type	GT	Vehicle height, LF	Vehicle height GF									
			200	205	210	215	220	225	230	235	240	245
6100+/190	190	150	220	225	230	235	240	245	250	255	260	265
6100+/195	195	155	220	225	230	235	240	245	250	255	260	265
6100+/200	200	160	220	225	230	235	240	245	250	255	260	265
6100+/205	205	165	220	225	230	235	240	245	250	255	260	265
6100+/210	210	170	220	225	230	235	240	245	250	255	260	265
6100+/215	215	175	220	225	230	235	240	245	250	255	260	265
6100+/220	220	180	220	225	230	235	240	245	250	255	260	265
6100+/225	225	185	220	225	230	235	240	245	250	255	260	265
6100+/230	230	190	220	225	230	235	240	245	250	255	260	265
6100+/235	235	195		225	230	235	240	245	250	255	260	265
6100+/240	240	200			230	235	240	245	250	255	260	265

H - Ceiling height

Example configuration



Example: Vehicle height, LF 165 cm and vehicle height, GF 220 cm.

Type: 6100+/205

Ceiling height: 240 cm

Type	GT	Vehicle height, LF	Vehicle height GF									
			200	205	210	215	220	225	230	235	240	245
6100+/190	190	150	220	225	230	235	240	245	250	255	260	265
6100+/195	195	155	220	225	230	235	240	245	250	255	260	265
6100+/200	200	160	220	225	230	235	240	245	250	255	260	265
6100+/205	205	165	220	225	230	235	240	245	250	255	260	265
6100+/210	210	170	220	225	230	235	240	245	250	255	260	265

H

Width dimension and door height



We recommend platform widths of minimum 250 cm and driving lane widths of 650 cm in order that vehicles can comfortably access the Multiparking system and enter and leave without difficulty.

Narrower platforms may impede parking according to the following criteria.

- Driving lane width
- Entrance conditions
- Vehicle dimensions

1 Observe minimum driving lane width in accordance with local regulations.

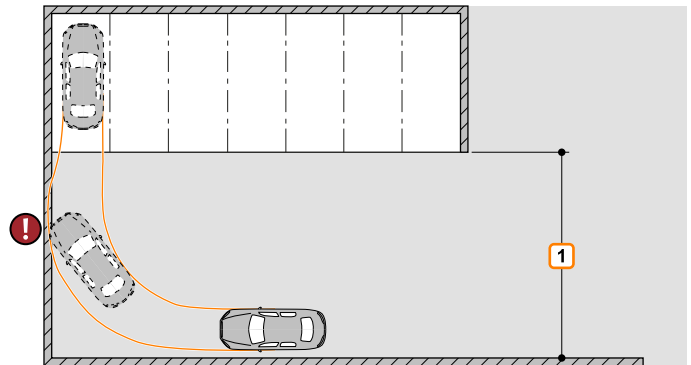

For commercial use of doors with electrical drive systems, an inspection log is required in accordance with ASR A1.7 'Technical rules for workplaces' in Germany. The door must be inspected by an expert before commissioning and annually thereafter and the result entered in the inspection log. The inspection must be carried out independently of maintenance. Observe local regulations on operation of electrical doors.

Configuration with sliding door

	Door versions		Supports per grid	Supports per second grid						
Sliding door inside the supports			Not possible!							
	Clear platform width	RB 3		Supports per grid	B3	B4				
Width dimensions	230	250	Not possible!	500	480					
	240	260		520	500					
	250	270		540	520					
	260	280		560	540					
	270	290		580	560					
	Vehicle height GF									
	200	205	210	215	220	225	230	235	240	245
H2	220	225	230	235	240	245	250	255	260	265

1 Observe minimum clear height H2 in accordance with local regulations.

2 GL = building length (see "Overview of building configuration", page 3).

3 RB = grid width. These dimensions **must** be adhered to.

Configuration with sliding door

	Door versions		Supports per grid		Supports per second grid					
Sliding door behind the supports										
	Clear platform width	RB ³	Supports per grid		Supports per second grid					
			B1	B2	B3	B4				
Width dimensions	230	250	250	230	500	480				
	240	260	260	240	520	500				
	250	270	270	250	540	520				
	260	280	280	260	560	540				
	270	290	290	270	580	560				
	Vehicle height GF									
	200	205	210	215	220	225	230	235	240	245
H2	210	215	220	225	230	235	240	245	250	255

- ¹ Observe minimum clear height H2 in accordance with local regulations.
- ² GL = building length (see "Overview of building configuration", page 3).
- ³ RB = grid width. These dimensions **must** be adhered to.

Loading schedule



The systems are dowelled into the ground. The drill hole depth in the floor plate is approx. 15 cm, in the walls approx. 12 cm. The floor plate and walls must be from concrete (quality min. C20/25). The dimensions for the bearing points have been rounded. If the precise figures are required, please consult KLAUS Multiparking.

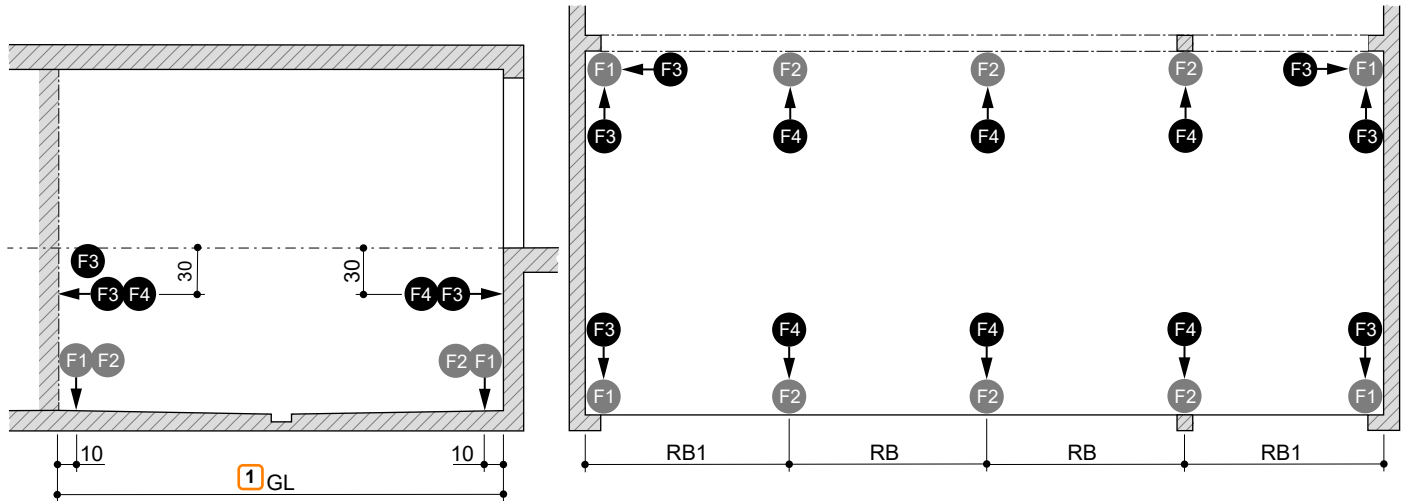

Parking space load	F1	F2	F3	F4
2000 kg	+ 34.0 kN - 11.8 kN	+ 42.0 kN - 23.6 kN	± 2.9 kN	± 5.8 kN
2600 kg	+ 37.0 kN - 14.2 kN	+ 74.0 kN - 28.2 kN	± 3.0 kN	± 6.0 kN
3000 kg	+ 40.0 kN - 15.8 kN	+ 80.0 kN - 31.6 kN	± 3.1 kN	± 6.2 kN

Clear plat-form width	RB ²	RB1
230	250	260
240	260	270
250	270	280
260	280	290
270	290	300

- ¹ GL = building length
- ² RB = grid width. These dimensions **must** be adhered to.

Arrangement of grids – KombiSystem

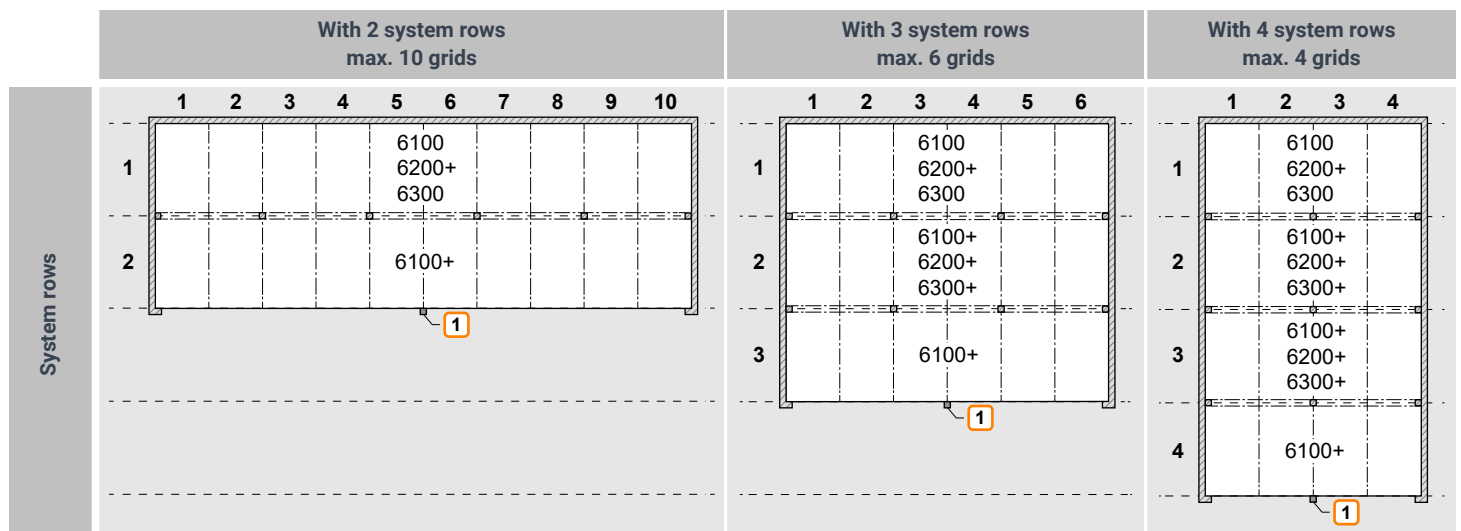

- ¹ Control panel

Access incline



The maximum access inclines specified in the symbol sketch must not be exceeded. Improper configuration can lead to extreme difficulty accessing the system, for which KLAUS Multiparking cannot be held liable. Where above-ground garages are on a slope, provision of a drainage gutter in the access is recommended.

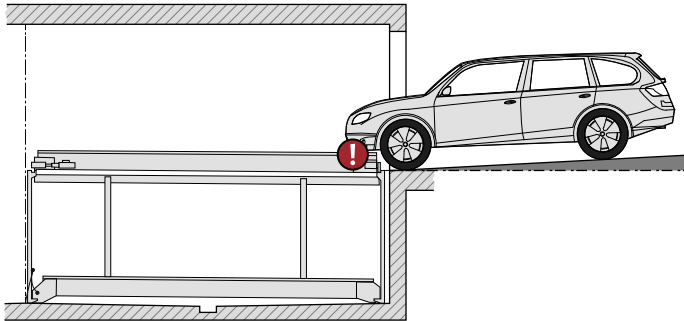

max. 3% slope

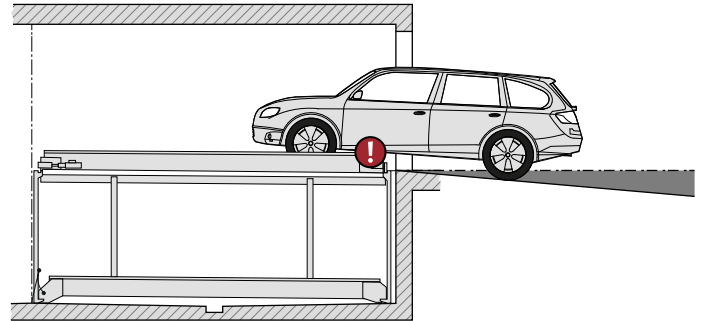

max. 5% gradient

Clearance for installations

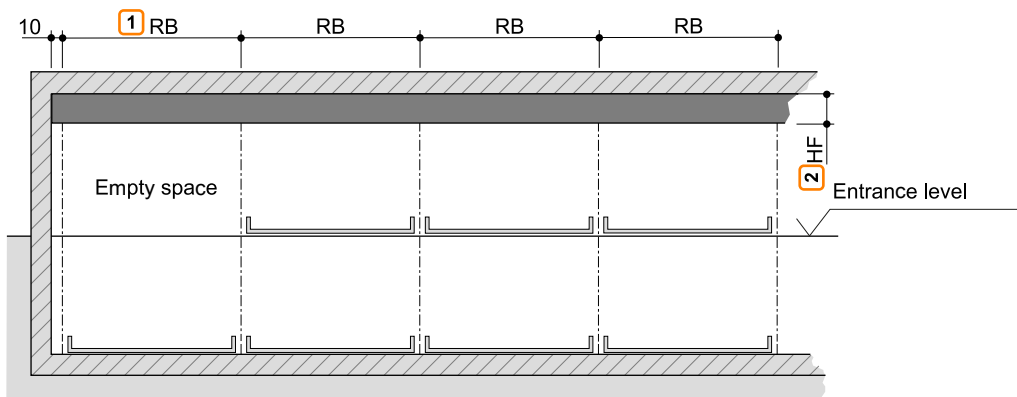



1 RB = grid width. These dimensions **must** be adhered to.

2 HF: Clearance height. Depending on building height and door version.

■ Clearance for cable routing above the door

CE conformity

The systems provided are consistent with DIN EN 14010, the VDMA 15423 specification and the EC Machinery Directive 2006/42/EC. This system has also undergone a voluntary compliance test conducted by TÜV SÜD.

ZERTIFIKAT ◆ CERTIFICATE ◆ 認証証書 ◆ CERTIFICADO ◆ CERTIFICAT	 Industrie Service
	<h2>Certificate concerning the examination of conformity</h2>
	Certificate no: CA 696
	Certification body: TÜV SÜD Industrie Service GmbH Westendstr. 199 80686 München – Germany
	Applicant / Certification holder: KLAUS Multiparking GmbH Hermann-Krum-Str. 2 88319 Aitrach – Germany
	Manufacturer: KLAUS Multiparking GmbH Hermann-Krum-Str. 2 88319 Aitrach – Germany
	Product: Equipment for power driven parking of motor vehicles
	Type: TrendVario 6100 / 6100+ and 6300 / 6300+ 2.000 kg, 2.600 kg, 3.000 kg
	Directive: 2006 / 42 / EC, Annex I
	Test specifications: DIN EN 14010:2003+A1:2009
Date and number of the test report / mark of conformity: No. CA 696 from 2023-03-17	
Result: The equipment fulfills the requirements of the test specifications for the respective scope of application stated in the annex (page 1) of this certificate, keeping the mentioned conditions.	
Date of issue: 2023-03-31	
Validity: 2028-03-30	
 Bernd Gründling Zertifizierstelle der Fördertechnik	
 TÜV [®]	

Electrical installation

Switch cabinet and master switch

Access to the switch cabinet (about 60 x 60 x 25 cm) must be possible without danger. The lockable master switch must be positioned so that the entire entry area of the facility can be surveyed.

With wall opening from switch cabinet to system (consultation with KLAUS Multiparking required).

Hydraulic unit

- 3.0 kW, three-phase current 230/400 V / 50 Hz

Alternative versions for a surcharge:

- 5.2 kW, three-phase current 230/400 V / 50 Hz for shorter access times.
- One hydraulic unit per row (3 kW or 5.2 kW) for shorter access times.

Supply cable to master switch

With one hydraulic unit:

Customer-provided supply cable min. 5 x 2.5 mm² (3 PH+N+PE) to master switch with pre-fuse 3 x 16 A (slow) or circuit breaker 3 x 16 A (trip characteristic K or C).

With multiply hydraulic units:

Customer supply cable at least 5 x 2.5 mm² to master switch with pre-fuse 3 x 32 A (slow) or circuit breaker 3 x 32 A (trip characteristic K or C). DIN/VDE and local regulations of energy-supply companies must be observed (see "Supply cable to master switch - foundation earth", page 13).

Control panel with emergency-stop

- Attachment at a clear point (e.g. pillar).
- Secured against external operation.

Technical information

Usage area

The system is suitable for a fixed group of users as standard.

Where users change (e.g. short-term parking in office buildings or hotels), structural modifications to the Multiparking system are required. Please request a consultation if required.

Units

Low-noise, bearing-mounted hydraulic units are installed on rubber-metal blocks. Consequently, we recommend separating the garage body from the residential building.

Parking space designation

Please consult the function diagram for the standard designation of the parking spaces (see "Function diagram with standard designation", page 2). Alternative designations are possible with a surcharge.

Please note the following specifications:

- The empty space is situated on the left as standard.
- Any alternative designations must be notified 8 to 10 weeks before delivery.

Ambient conditions

Ambient conditions for the areas around Multiparking systems:

Temperature range -10 to +40° C. Relative humidity 50 % to a maximum external temperature of +40° C.

If ascent/descent times are specified, these relate to an ambient temperature of +10° C and with the system positioned immediately adjacent to the hydraulic unit. These times are increased at lower temperatures or with longer hydraulic lines.

Building application documents

Multiparking systems generally require approval. Please observe local regulations and stipulations.

Care

To prevent corrosion damage, please observe our special cleaning and care instructions and ensure that your garage is well ventilated.

Corrosion protection

In accordance with the 'Corrosion protection' supplement.

Electrically driven doors

For commercial use of doors with electrical drive systems, an annual inspection is required in accordance with ASR A1.7 'Technical rules for workplaces' in Germany. We urgently recommend concluding a maintenance contact as these services are included for the complete system.

CE conformity

The systems provided are consistent with DIN EN 14010, the VDMA 15423 specification and the EC Machinery Directive 2006/42/EC. This system has also undergone a voluntary compliance test conducted by TÜV SÜD.

Noise protection

Standard noise protection:

In accordance with DIN 4109-1 Noise protection in high-rise - Section 9: Maximum sound pressure level in living and sleeping areas 30 dB (A). User noise is not subject to the requirements.

The following dimensions are required for adherence to this value:

- Noise protection package in accordance with quote/order (KLAUS Multiparking)
- Sound insulation dimension of the building structure of min. R'_w = 57 dB (service to be provided by the customer)

Increased sound protection (special agreement):

In accordance with DIN 4109-5 Increased noise protection in high-rise - Section 8: Maximum sound pressure level in living and sleeping areas 25 dB (A). User noise is not subject to the requirements.

The following dimensions are required for adherence to this value:

- Noise protection package in accordance with quote/order (KLAUS Multiparking)
- Sound insulation dimension of the building structure of min. R'_w = 62 dB (service to be provided by the customer)

Note:

User noise is noise that can be influenced individually by the user of our Multiparking systems. This includes, e.g., accessing the platform, the slamming of vehicle doors, engine and brake noise.

Performance specification

Description

Multiparking system for independent parking of vehicles one on top of and next to one another.

The system is traversable and is combined with the TrendVario 6100, 6100+, 6200+, 6300 and 6300+ (details on these systems can be found on the corresponding product sheets).

Dimensions in accordance with the underlying pit, width and height dimensions.

Access to the parking spaces horizontally (installation tolerance $\pm 1\%$).

An access must be provided over the entire width of the system (minimum driving lane width in accordance with local regulations).

The parking spaces are arranged on 2 levels one on top of the other. Vehicles park on stable steel platforms.

The platforms on the basement level (LF) move vertically, the platforms on the ground level (GF) move horizontally. At entrance level (GF), there is always 1 parking space less. This empty space is used for sideways movement of the GF parking spaces to allow a parking space on the LF below to rise to entrance level. Consequently, 3 parking spaces (1 on GF, 2 on LF) is the smallest unit for this parking system.

Vehicle positioning in any parking space by positioning aid mounted on one side (to be adjusted in accordance with the operating instructions).

For safety reasons, the movement operation of the platforms always takes place behind locked doors.

All requisite safety equipment is integrated into the system. This essentially comprises a chain monitoring system, locking levers for the lower platforms and locked doors. The doors can only be opened when the selected parking space has reached its parking position and all fall openings are secure.

Steel frame (secured in the pit) comprising:

- Supports (arranged in rows)
- Crossbeams and lengthways beams
- Sliding rails for the sideways moving GF platforms

Platforms comprising:

- Platform profiles
- Adjustable positioning aid
- Chamfered ramps
- Side beams
- Crossbeams
- Feeder platform (only LF)
- Screws, nuts, washers, spacers, etc.

Lifting equipment for platforms on the LF comprising:

- Hydraulic cylinders with solenoid valves
- Chain wheels
- Chains
- Limit switches
- The platforms are each suspended at 4 points and are guided at the supports by means of plastic plain bearings

Drive unit for sideways moving platforms on GF:

- Gear motor with chain wheel
- Chains
- Sliding and guide rollers (low-noise)
- Power supply via energy chain

Hydraulic unit comprising:

- Hydraulic unit (low-noise, fitted to bracket and bearing mounted on rubber-metal block)
- Hydraulic oil tank
- Oil filling
- Internal gear pump
- Pump holder
- Coupling
- Three-phase motor
- Noise protection, motor protection switch and control fuse
- Test pressure gauge
- Pressure relief valve
- Hydraulic hoses (to attenuate noise transmission to the hydraulic pipes)

Control:

- Central control point (control panel with emergency-stop) for selecting the desired parking space
- The electrical wiring from the system cabinet is provided by the supplier

Sliding doors:
Size

- Sliding doors, size approx. 2500 mm x 2000 mm (width x height).

Frame

- Frame structure with one vertical centre rung from extruded aluminium profile (anodised, coating thickness approx. 20 µm)
- A handle shell is provided in a vertical aluminium profile for opening the doors.
- There is a rubber lip on the closing edge for a clean seal with the building.

Standard door filling

Aluminium perforated plate

- Thickness 2 mm, RV 5-8 E6/EV1, anodised, coating thickness approximately 20 µm
- Ventilation cross-section of the filling approx. 40%

Alternative door filling

Plain aluminium sheet

- Thickness 2 mm E6/EV1, anodised, coating thickness approximately 20 µm

Corrugated steel sheet

- Thickness 1 mm galvanised, coating thickness approximately 20 µm
- Additional powder coating, coating thickness approx. 25 µm on the outside and approx. 12 µm on the inside
- Colour options on the outside (building view):

RAL 1015 (light ivory)	RAL 3003 (ruby red)
RAL 5014 (pigeon blue)	RAL 6005 (moss green)
RAL 7016 (anthracite grey)	RAL 7035 (light grey)
RAL 7040 (window grey)	RAL 8014 (sepia brown)
RAL 9006 (white aluminium)	RAL 9016 (traffic white)

- Door inside in a light grey tone

Wood filling

- Nordic spruce in A sorting
- Vertical tongue and groove boards
- Colourless, pre-coated

Composite safety glass

- Composite safety glass from 8/4 mm

Wire mesh

- Mesh size 12 x 12 mm
- Wire diameter 2 mm, galvanised, coating thickness approx. 20 µm
- Ventilation cross-section of the filling approx. 70%

Sliding rails

- The running gear comprises 2 double-pair roll systems per door, height-adjustable
- The sliding rails of the doors are attached to brackets with cover bushings or directly to the concrete lintel or a building-specific door suspension
- The lower guide comprises 2 plastic rollers on a base plate which is dowelled to the floor
- Sliding rails, cover bushings, guide roller base plate are galvanised

Door actuation

- Electrical drive system by means of electric motor attached to the rail system in the turning point of the sliding doors. The drive pinion engages a chain attached to the door.

For safety reasons, the movement operation of the platforms always takes place behind locked doors. An electrical signal generator is used to query the positions 'door open' and 'door closed'.

Separation (if required)

- On request

Please note:

Door apertures (at the side, cover over the sliding rails, etc.) and door suspensions are not included with the standard configuration but can be supplied as special equipment with a surcharge.

Services to be provided by the customer

Barriers

Barriers that may be required in accordance with DIN EN ISO 13857 to secure the pits where there are roadways immediately in front of, adjacent to or behind the systems. This also applies during the construction stage.

Parking space numbering

Parking space numbering, if required.

Building services systems

Any lighting, ventilation, fire-extinguishing and fire-alarm systems that may be required, plus clarification and compliance with corresponding official documentation.

Lighting

The customer must observe local regulations pertaining to the illumination of parking spaces and roadways. In accordance with DIN EN 12464-1 'Light and lighting - Lighting of work places', an illumination level of min. 200 lx is recommended for the parking spaces and operating area of the system. A floating contact can be provided for actuation of parking space lighting provided by the customer.

Drainage

Functional drainage of the pit must be provided by means of, for example, a water collection channel towards the centre that is connected to the sewer system or a pump sump. The channel may contain a lateral slope, but not in the other pit areas (lengthways slope is already provided by the building dimensions). In the interests of environmental protection, we recommend coating the pit floor. Oil and/or fuel separators should be installed in accordance with local regulations.

Strip foundations

Due to structural conditions, the customer must erect an accessible platform when constructing strip foundations, level with the upper edge of the strip foundation.

Wall openings

Wall openings, if required.

Supply cable to master switch - foundation earth

The customer must lay the supply cable to the master switch during assembly. Functional capability can be checked by our engineers on site, in conjunction with the electronics engineer. If this is not possible during assembly for reasons attributable to the customer, the customer must commission an electronics engineer.

The customer must earth the steel structure with a foundation earth connection (earthing distance max. 10 m) and equipotential bonding in accordance with DIN EN 60204.

Door suspensions

Please note that if the specified clear heights (see "Width dimension and door height", page 5) are not adhered to, additional measures for door attachment (door suspensions) will be required for a surcharge.

Door apertures

Door apertures, if required. This may be requested from KLAUS Multiparking for a surcharge.

Subject to technical changes

In the course of technical progress, KLAUS Multiparking shall be entitled to use newer or different technologies, systems, processes or standards to provide the services than initially offered, provided that this does not disadvantage the customer in any way.

KLAUS Multiparking GmbH

Hermann-Krum-Straße 2
88319 Aitrach / Germany

+49 (0) 7565 508-0

info@multiparking.com
www.multiparking.com

